

# Weighing in Systems!

High-end Weighing Technology  
for Logistics and Material Handling

Competence in dynamic weighing.

A Wipotec Brand



CHECKWEIGHERS

# Innovative solutions for package

## OCS as your total solutions system partner

As the leading manufacturer of high performance checkweighers and catchweighers, OCS Checkweighers is reputed worldwide as the industry's system partner.

With a great variety of suitable application solutions, OCS is able to satisfy individual demands. The fact that it manufactures its own key weighing-engineering components speaks for itself! High speed, reproducible precision and absolute system reliability are the decisive factors.

OCS checkweighers are predestined for weight measurement for products in the logistics branch, especially parcels service and post, mail order business, banks, insurance companies and generally in intra-logistics.

Optimal product handling and the diversity of package and letter formats require modern and intelligent scale engineering.

Convincing expertise, yearlong experience and provable success in various areas of materials handling are the supporting pillars of our efforts and offer the benefits you are looking for.

OCS solutions provide you with the flexibility and efficiency you need!

### OCS checkweighers and catchweighers

#### fulfil your quality requirements:

- Determination of the weight:  
fast, precise and officially calibrated
- Classification of selectable limits
- Completeness control during dispatching
- Stamping and postage control
- Counting of consignments
- Volume and format determination
- Barcode recognition (multisided)
- High throughput speeds

## Examples of successfully implemented applications - And what may we do for your weighing needs?

	Low requirements		Medium requirements		High requirements	
<b>Application</b>	Parcels, suitcases (train, airport)	Letters, flats	Parcels	Letters, flats	Parcels	Letters, flats
<b>Product transport direction</b>	horizontal	horizontal	horizontal	horizontal and vertical	horizontal	vertical
<b>Speed</b>	≤ 0.8 m/s (often start/stop)	≤ 0.8 m/s (often start/stop)	≤ 1.2 m/s	≤ 1.6 m/s	≤ 3 m/s	≤ 4 m/s
<b>Throughput</b>	≥ 1,200/h	≥ 1,200/h - 1,800/h	≤ 2,500/h	≥ 4,500 - 6,000/h	up to approx. 7,000/h (HC-FL)	up to approx. 20,000/h per line
<b>Weighing range</b>	up to approx. 60 kg	5 g - 5,000 g	up to approx. 60 kg	3,500 g	up to approx. 60 kg	up to approx. 0.5 kg (flat 2 kg)
<b>Precision</b>	≥ 5 g	≥ 1 g	≥ 5 g	≥ 1 g	≥ 10 g	≥ 2 g

# and letter automation

## Parcel sorting

Each parcel is individual and unique. That means almost chaotic product sequences with extreme requirements on your system components.

With exemplary flexibility, the modular construction of OCS catchweighers meet your demands on transport speed, operational mode, throughput and integration speed. That means integration into both existing and new systems is completely unproblematic.



### DWS-System

#### Dimensioning Weighing Scanning

The new DWS-System consists of three components that fulfil three things at the same time. And do so with minimal space requirements:

- Registration of parcel volumes, weight and barcode for complete invoicing (Revenue Recovery)
- Integration of a standard catchweigher or double weigher (HC-FL)
- Transfer of all information to a central data management system
- Data storage is subordinate to calibration-engineering regulations (alibi storage function)
- User friendly operation (one desktop)
- Approved system (PTB/OIML)

## Letter sorting

The degree of automation of high performance letter sorting systems has increased drastically. At the same time, the variety of the "letter" product has grown. The result is that the technical requirements on individual system components are higher.

With its weighing technology, OCS makes allowances for the growing organizational demands of mail service intralogistics, which allows an ever-smaller time-window for processing the pieces. Modern sorting systems carry out a great number of processes with a high rate of throughput quasi parallel. The performance (hourly throughput) and the reliability of data acquisition (weight, format, address, etc.) are all of great importance.

### Ideal solutions

Along with our own control system for the conveyor belts that generate a stable speed, OCS provides:

- Equipment, measurement and transport engineering for your application

### Flexible product handling

We adapt to your product ideally.

Regardless of its characteristics:

- During chaotic product weighing (letter formats C6 to B4)
- Horizontal transport up to approx. 1.6 m/s
- Vertical transport up to approx. 4 m/s
- Multitrack applications with a throughput of up to 20,000 pc./h/line
- Size and format determination



CHECKWEIGHERS

# Tailor made solutions for the future

## Innovative and trendsetting

“At the right time, at the right place, in the right quantity and quality!”, that’s what the ideal situation in logistics, mail and express service looks like. Precise and fast weight acquisition with our scales contributes to counteracting the increasing cost pressures and to realizing tighter delivery time-windows. These tasks are reliably solved with a reliable partner - **OCS Checkweighers**.

International successes in past projects speak for themselves!

### Benefits exemplary for individual industries with use of OCS solutions:

#### Banks and insurance companies

*Quality assurance:* Letters are checked for completeness, e.g. for enclosed bankcards, number of pages of insurance policies.

#### Department stores

*Completeness monitoring:* Comparison of the target weight (based on the delivery note) with the actual value of a consignment.

#### Postal distribution centres

*Productivity increase:* Automated assessment of outgoing mail pieces to compile the invoice amounts between postal services and customers. By isolating the consignments, weight, number and format can be determined during speedy transit.

#### Post (Mail Sampling)

*Cost control (random sampling):* Multitrack systems for weight and format determination for standard letters and flats.

#### Parcel distribution centres

*Productivity increase:* Fast acquisition of volumes, weight and destination address of parcels for cost finding in huge distribution centres (e.g. air hubs).

### Parcel weighing

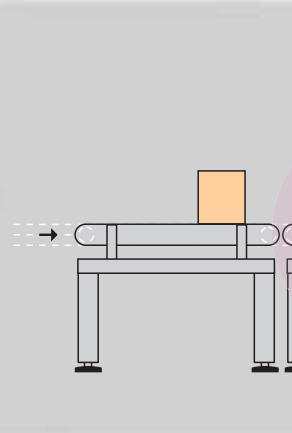

### Weighing within rapid letter

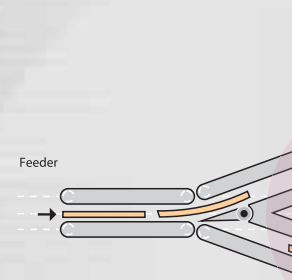

### Post Mail Sampling

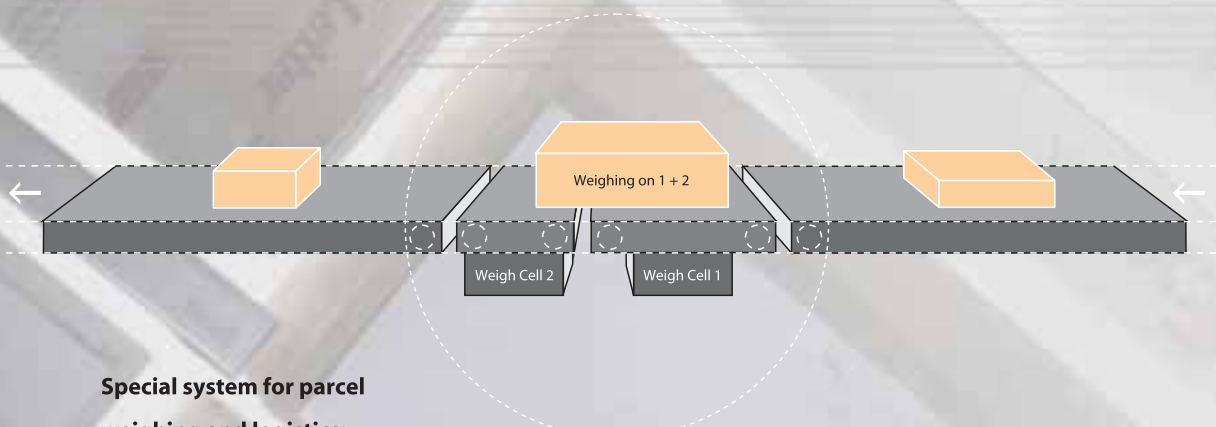
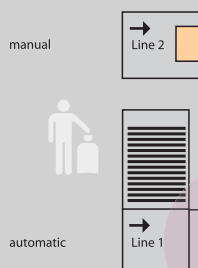

### Special system for parcel weighing and logistics:

- Double weigher (HC-FL) with two weighing belts in different lengths
- Approved and calibrated weighers according to OIML

# Some examples for illustration purposes...

Parcel identification and weight acquisition In- and Outbound

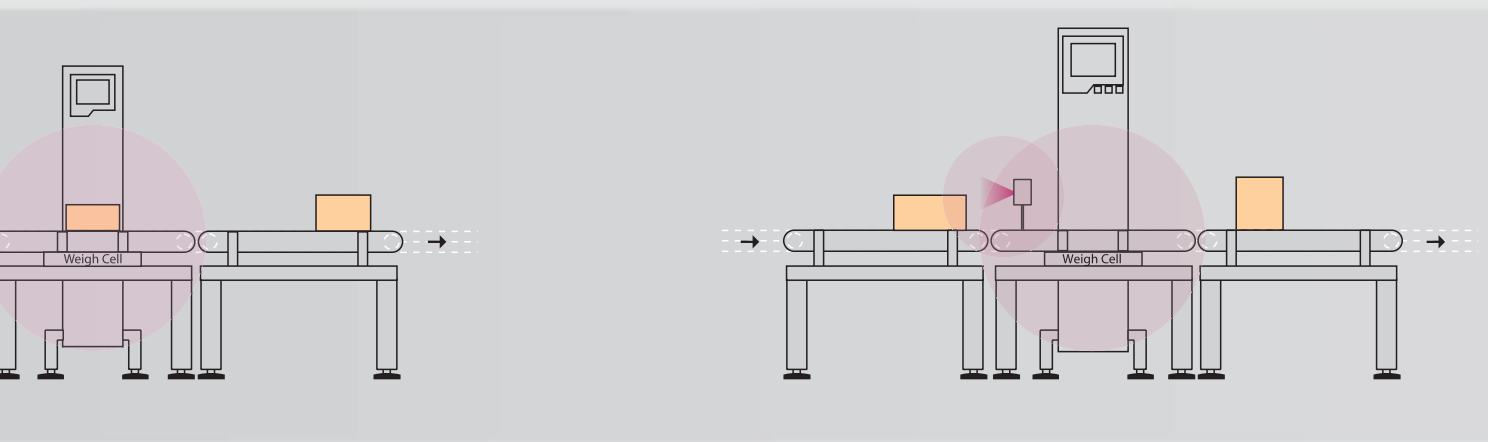

Parcel sorting

In-motion scale in Incline or Decline application

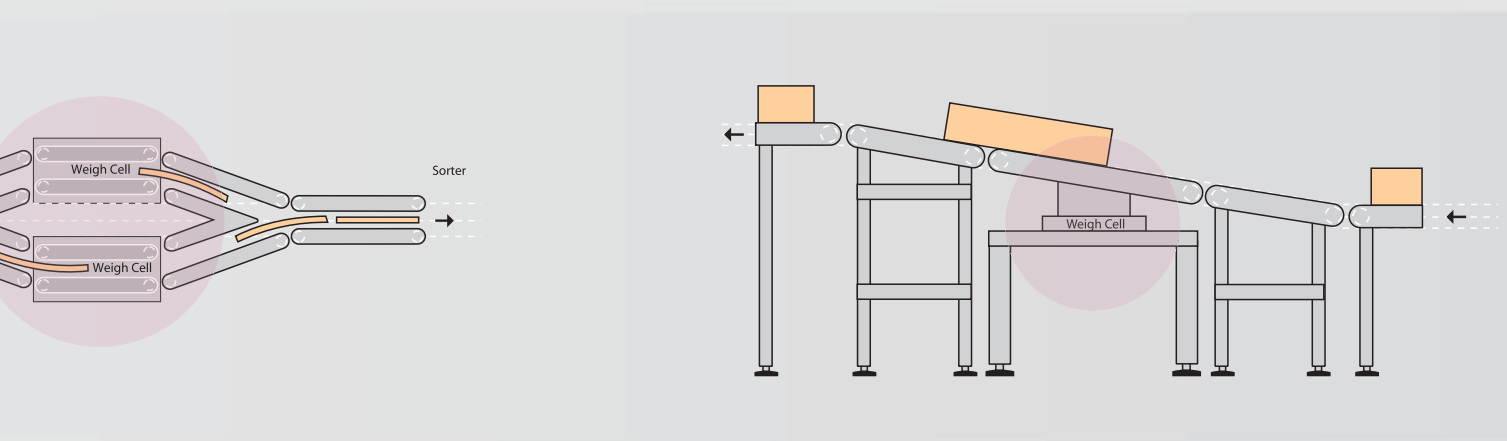

Letter and flat sorting system with franking by weight

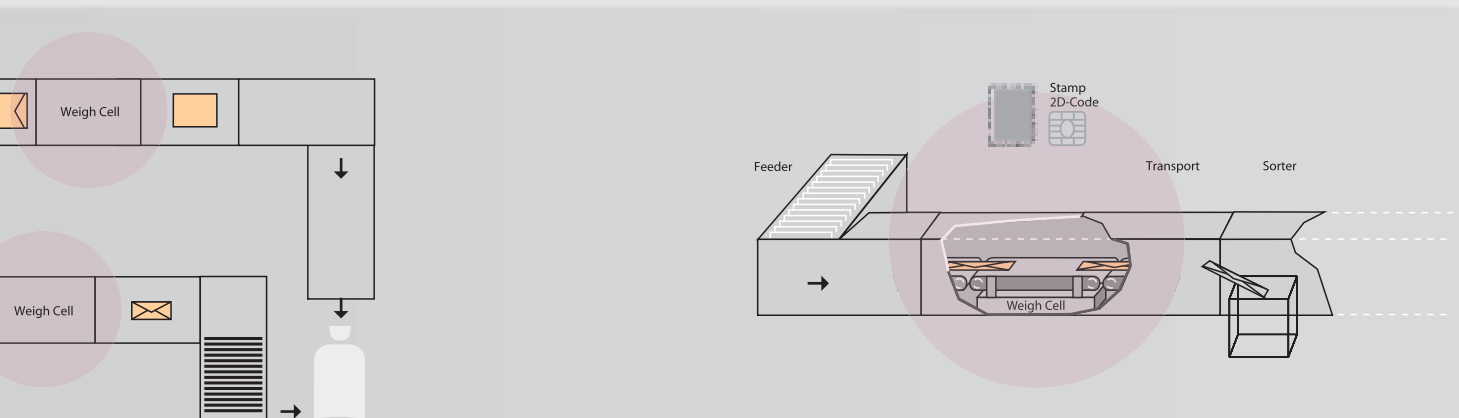

# ...with room for your entire individual application

HC-FL double weigher on mezzanine

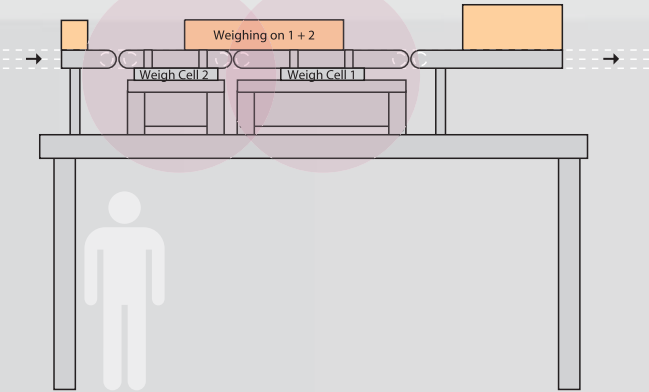

Infeed line with integrated weighing before tipping-counter

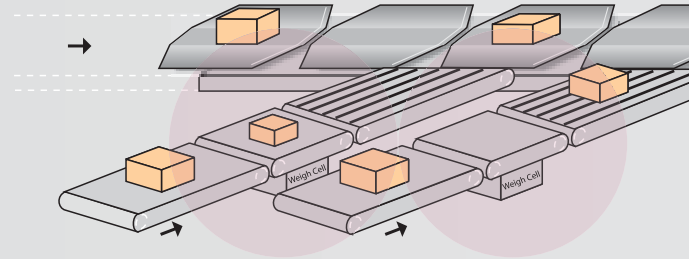

DWS System for product data acquisition and invoicing

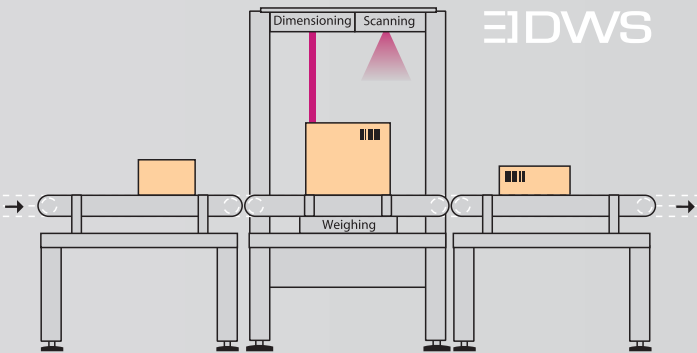

Completeness control in inserting machine

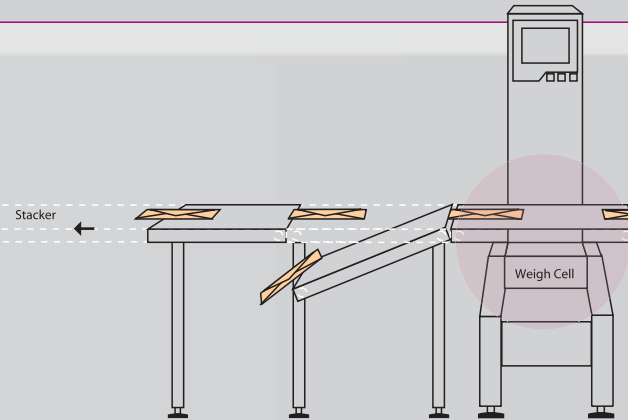

Vertical flat sorting

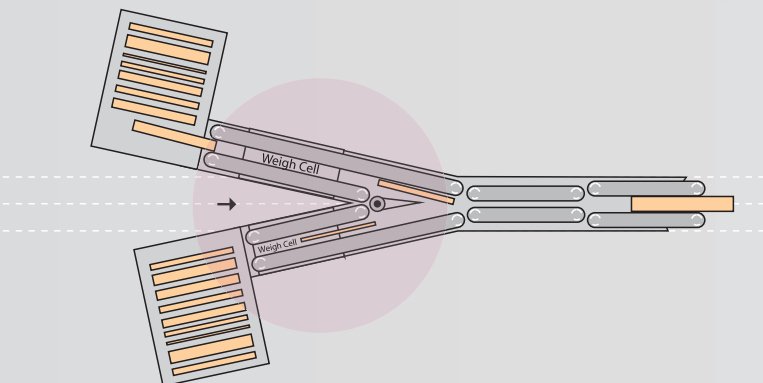

And now to your application!

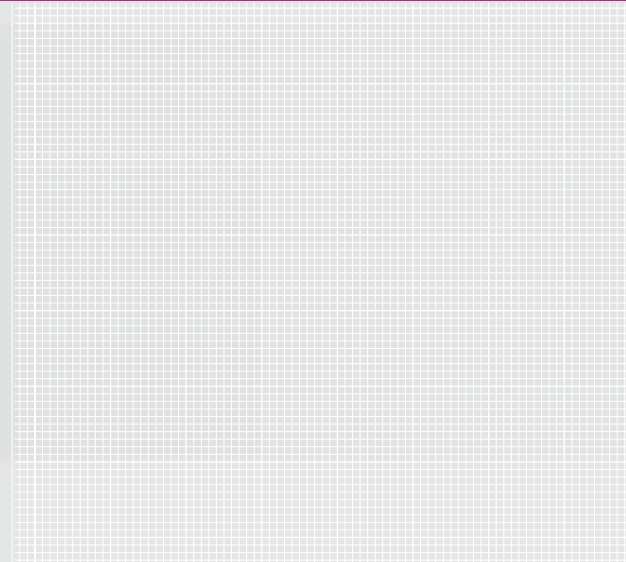

# Outstanding in precision and speed: Wipotec Weigh Cells

## Electro Magnetic Force Restoration (EMFR)

The Wipotec Weigh Cells used, superior to technically mature and traditional systems, are the guarantee for highest precision and product speeds. They are based on the Electro Magnetic Force Restoration principle.

The basic principle can be compared to a simple beam scale. The weight is placed on one side of the beam scale (coil arm). This causes the coil attached to the other side of the beam scale to try to lift up out of the magnetic field. An optical detection system (light barrier) sees every deflection - no matter how small - and reports this to a high-precision position controller, which regulates a coil current in such a manner that the beam scale remains balanced.

All that takes place within milliseconds, meaning the maximum deflections amount to less than a few nanometres.

The force initiated by the applied force is thus compensated by the coil current. At the same time, the strength of the current is proportion to the weight. The force-proportional current is measured through a precision resistor, converted into a digital signal using an analogue digital converter and processed in a microprocessor system for direct output as a digital weight value.

sorter

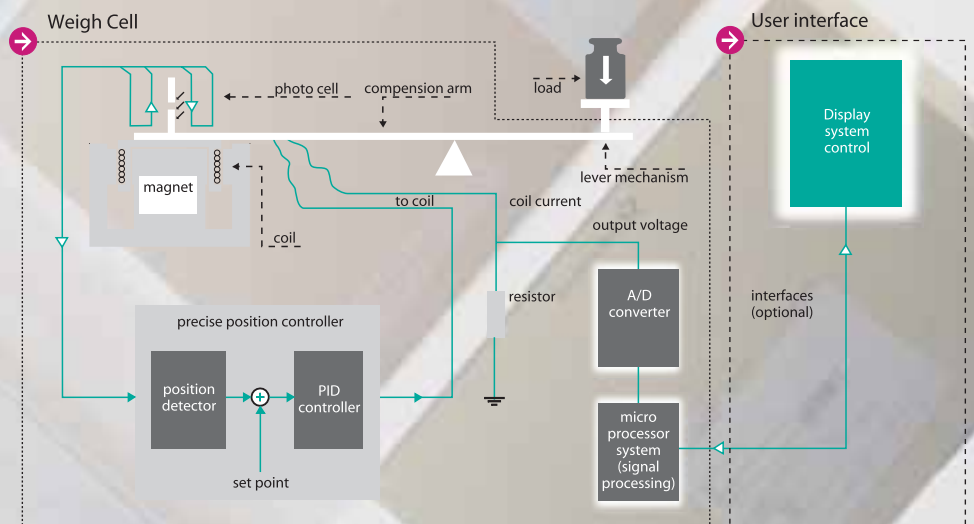
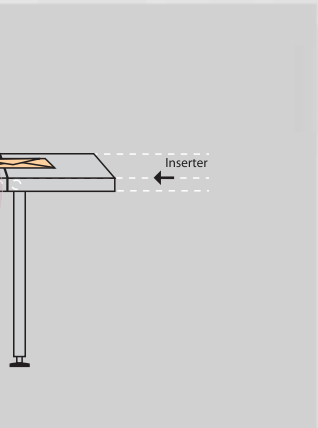
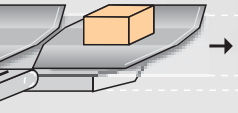

OCS checkweighers cover all areas of weighing technology and provide solutions for every task in the industrial sector

## HC-Series

High-performance checkweighers for high-end applications



## EC-M-Series

Standard checkweighers for mid-range applications



## EC-S-MB

Entry level checkweighers for standard applications

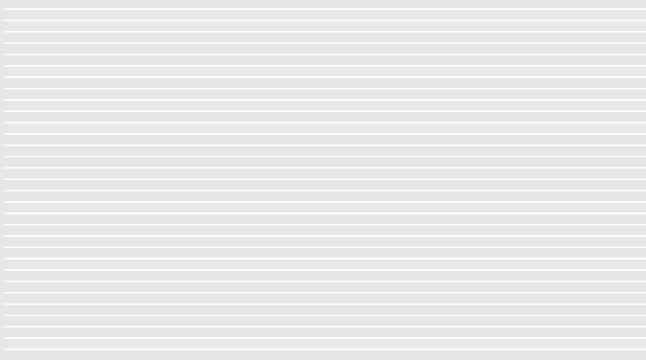

Close to you with our worldwide service and sales network

A Wipotec Brand



CHECKWEIGHERS